

TECHNICAL DATASHEET



FLANGE ADAPTOR

03 Update - 06/2022

TECHNICAL DATA

Article No	001 115 5100 0800
d (mm)	800
d1 (mm)	843
d2 (mm)	905
d3 (mm)	780
le (mm)	312
L (mm)	60
Z (mm)	463
s (mm)	47,4
Weight (Kg)	54,550
Box Quantity (pcs)	1
Box Dimension (cm)	

INJECTION MOULDED

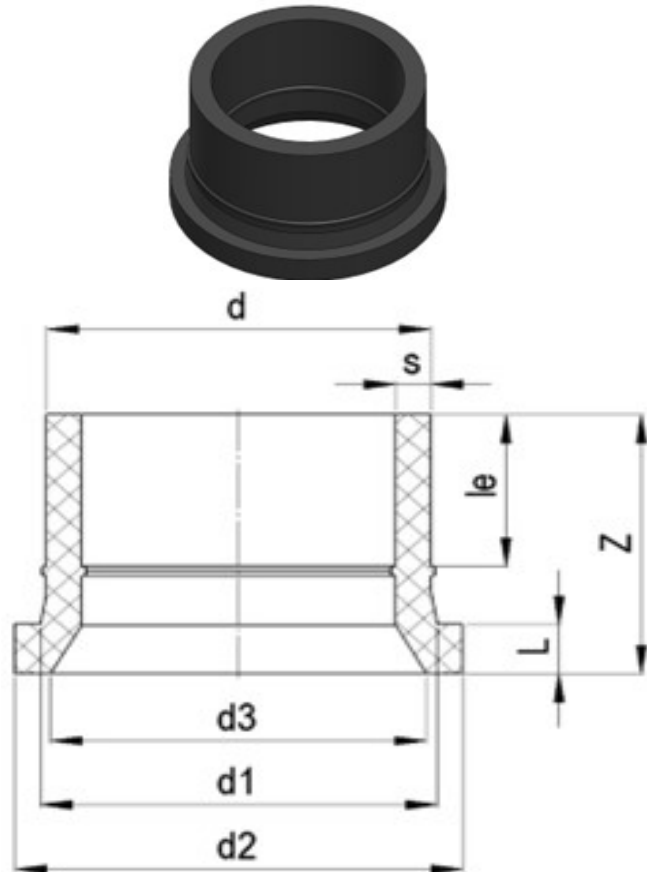

IDENTIFICATION OF PRODUCT

D(mm)	800
SDR	17
RAW METARIAL	PE 100
PRESSURE CLASS	10 Bar Water
TRADEMARK	NTG
EXECUTION	Injection Moulded+Pipe Extended
STANDARD	EN 12201-3

SPECIFICATION

Long Spigot
Suitable for butterfly valve
Chamfered finish, where d3 size is given
Extended with PE100 Pipe
Not suitable for ansi flange

Tolerance on diameters and thickness according to the standards. The other dimensions are specialized. Tolerance $\pm 5\%$. NTG PLASTIK reserves all the right to change any information without giving prior notice. The production, distribution and utilization of this document without explicit authorization is prohibited.

Fr 161 Rev 00